

PLT-68

60 MAGICLOTUS WORK TOP - TOP



Worktop with inox drawer cm.71x47x15h
inox



Construction - Fabricated using CrNi 18/10 AISI 304 grade Stainless Steel
Scotch-Brite Satin polish Finish, incorporating 1mm thick worktop,
rounded edges, chromed details and rear splash back. Model -
Professional worktop with or without drawer . Fittings - Adjustable feet.



ITALIAN CULINARY ART

The pictures are purely representative. The manufacturer reserves the right to modify the technical data and models without previous notice.

PLT-68

60 MAGICLOTUS
WORK TOP - TOP

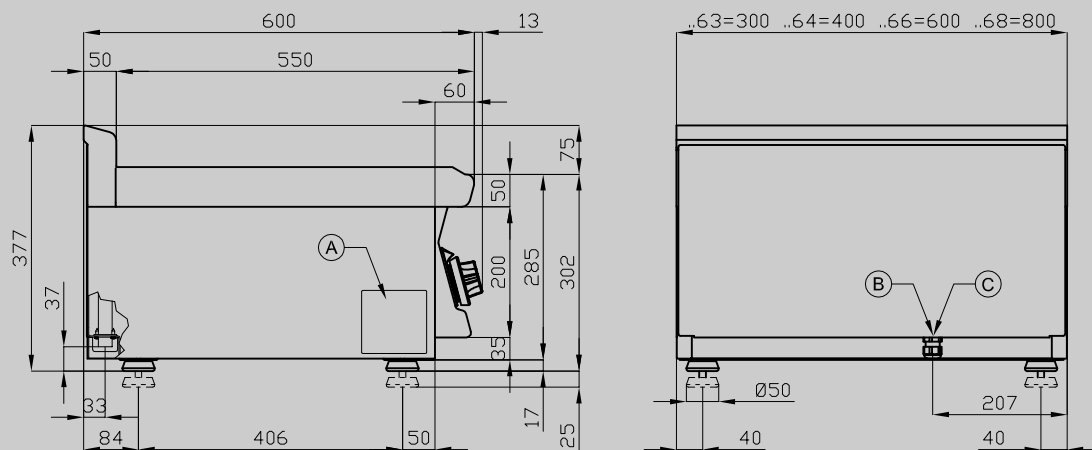

A	Data plate				
---	------------	--	--	--	--

MODEL: PLT-68
DIMENSIONS: cm. 80x 60x 28h



kg: 38
m³: 0.372
mm: 830x690x650

BUY LOTUS BUY ITALY

The pictures are purely representative. The manufacturer reserves the right to modify the technical data and models without previous notice.



LOTUS S.P.A. Via Calmaor, 46
31020 San Vendemiano(TV) - Italy
Tel. + 39 0438 778020 / 778468
Fax + 39 0438 778277
www.lotuscookers.it - lotus@lotuscookers.it