

PFT-68

60 MAGICLOTUS GRIDDLE ACCESSORIES

KIT front protection plan fry-top

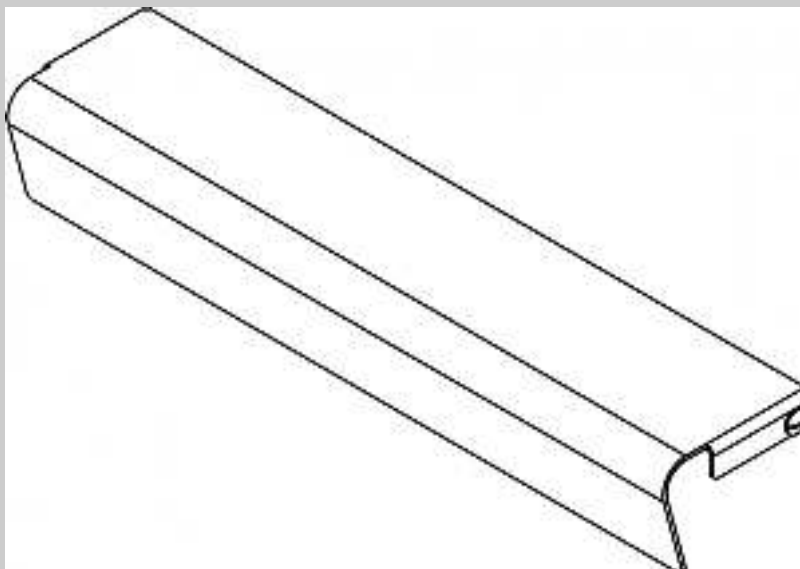

ITALIAN CULINARY ART

The pictures are purely representative. The manufacturer reserves the right to modify the technical data and models without previous notice.

PFT-68

60 MAGICLOTUS
GRIDDLE ACCESSORIES

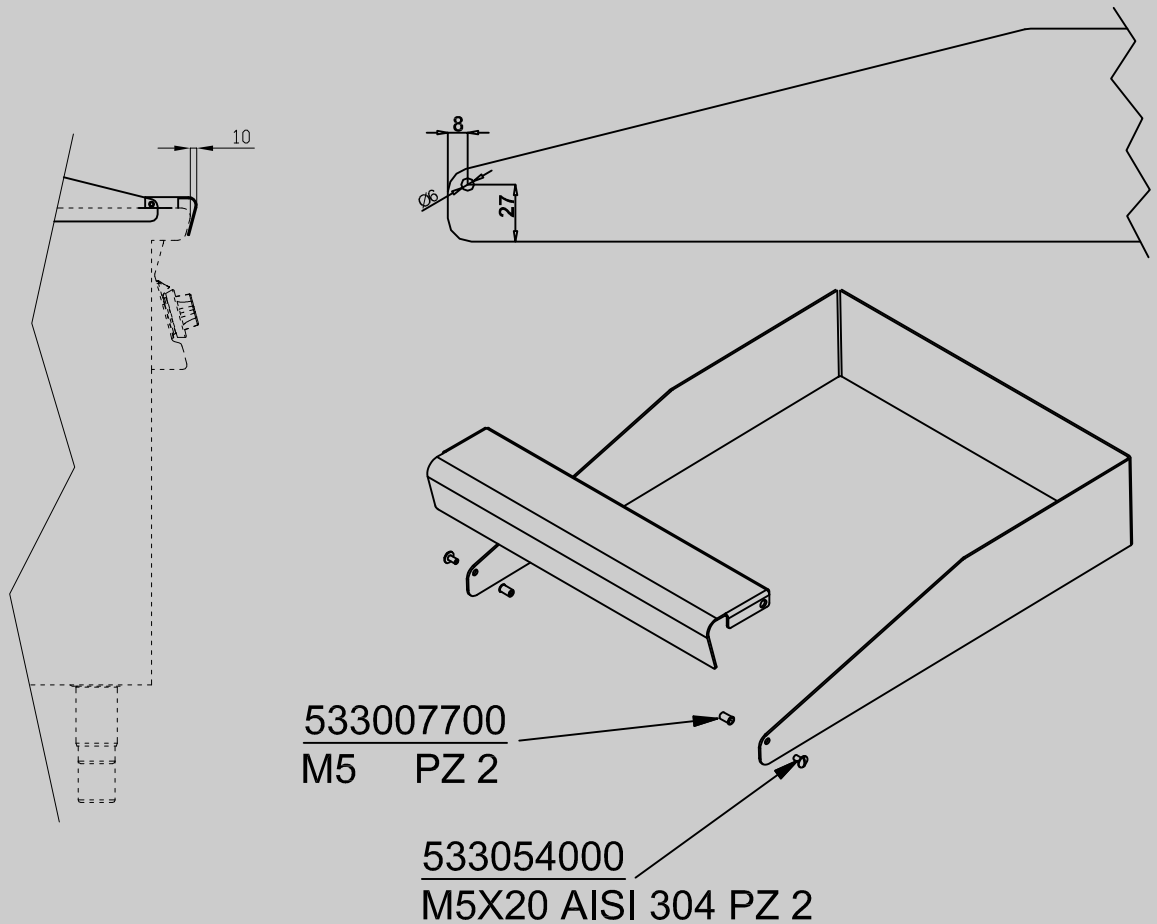

A	Data plate				
---	------------	--	--	--	--

MODEL: PFT-68
DIMENSIONS: cm. 78x 8x 6h



kg: 4
m³: 0.008
mm: 810x110x90

BUY LOTUS BUY ITALY

The pictures are purely representative. The manufacturer reserves the right to modify the technical data and models without previous notice.



LOTUS S.P.A. Via Calmaor, 46
31020 San Vendemiano(TV) - Italy
Tel. + 39 0438 778020 / 778468
Fax + 39 0438 778277
www.lotuscookers.it - lotus@lotuscookers.it