

RRV-66

60 MAGICLOTUS ACCESSORIES

Perforated shelf for heater element mod.RV
(NO CF)



ITALIAN CULINARY ART

The pictures are purely representative. The manufacturer reserves the right to modify the technical data and models without previous notice.

RRV-66

60 MAGICLOTUS ACCESSORIES

RV

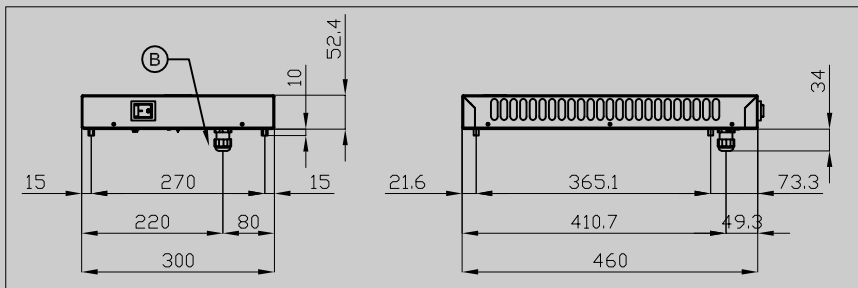

RRV

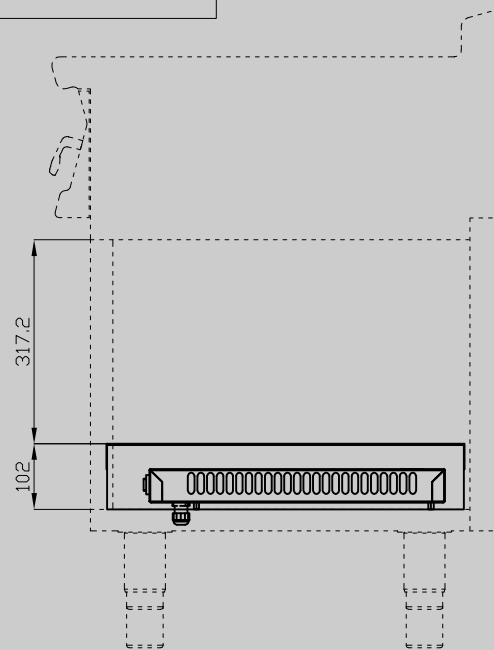
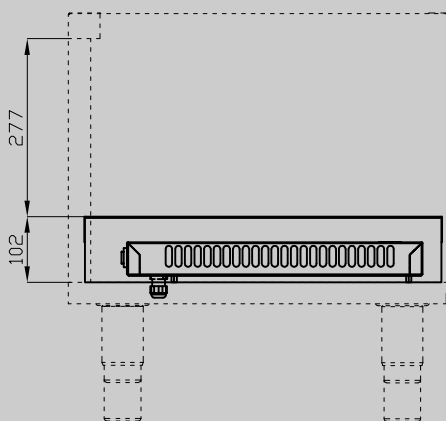
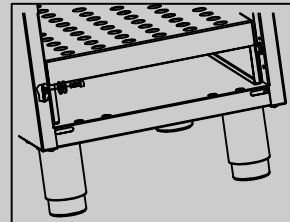

A	Data plate				
---	------------	--	--	--	--

MODEL:

RRV-66

DIMENSIONS:

cm. 54x 46x 10h



kg: 5
m³: 0.037
mm: 570x500x130

BUY LOTUS BUY ITALY

The pictures are purely representative. The manufacturer reserves the right to modify the technical data and models without previous notice.



LOTUS S.P.A. Via Calmaor, 46
31020 San Vendemiano (TV) - Italy
Tel. + 39 0438 778020 / 778468
Fax + 39 0438 778277
www.lotuscookers.it - lotus@lotuscookers.it