

M-610

60 MAGICLOTUS STAND

Open Stand 40/60



Construction - Fabricated using CrNi 18/10 AISI 304 grade Stainless Steel
Scotch-Brite Satin polish Finish, rounded edges and chromed details.

Model - Professional Stand*, also for Induction and Worktop Units.

Fittings - Appliance is supplied with adjustable feet, *Doors not
Included, except for Induction Unit top.



ITALIAN CULINARY ART

The pictures are purely representative. The manufacturer reserves the right to modify the technical data and models without previous notice.

M-610

60 MAGICLOTUS STAND

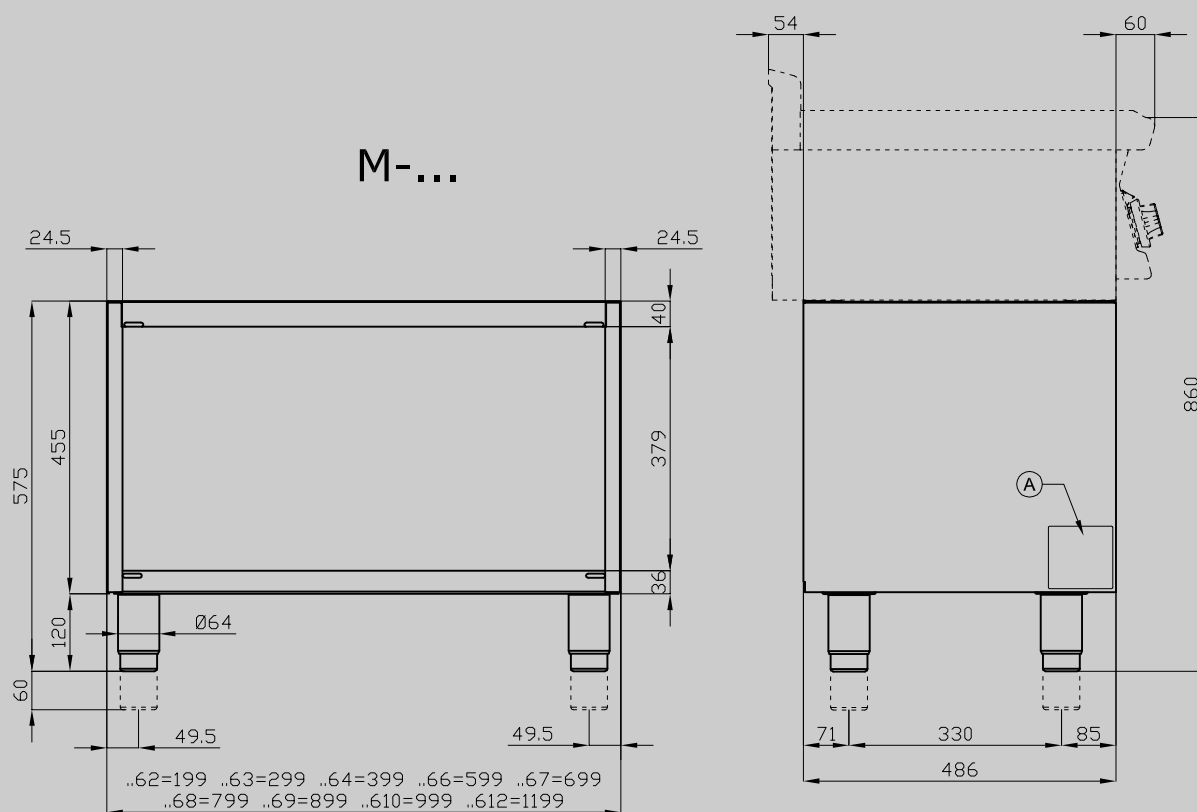

A	Data plate				
---	------------	--	--	--	--

MODEL: M-610
DIMENSIONS: cm. 100x 48,5x 57h



kg: 27
m³: 0.531
mm: 1030x670x770

BUY LOTUS BUY ITALY

The pictures are purely representative. The manufacturer reserves the right to modify the technical data and models without previous notice.



LOTUS S.P.A. Via Calmaor, 46
31020 San Vendemiano (TV) - Italy
Tel. + 39 0438 778020 / 778468
Fax + 39 0438 778277
www.lotuscookers.it - lotus@lotuscookers.it