

# S-66

## 60 MAGICLOTUS STAND

Stand



Construction - Fabricated using CrNi 18/10 AISI 304 grade Stainless Steel  
Scotch-Brite Satin polish Finish, rounded edges and chromed details.

Model - Professional Stand\*, also for Induction and Worktop Units.

Fittings - Appliance is supplied with adjustable feet, \*Doors not  
Included, except for Induction Unit top.



ITALIAN CULINARY ART

The pictures are purely representative. The  
manufacturer reserves the right to modify the  
technical data and models without previous  
notice.

# S-66

## 60 MAGICLOTUS STAND

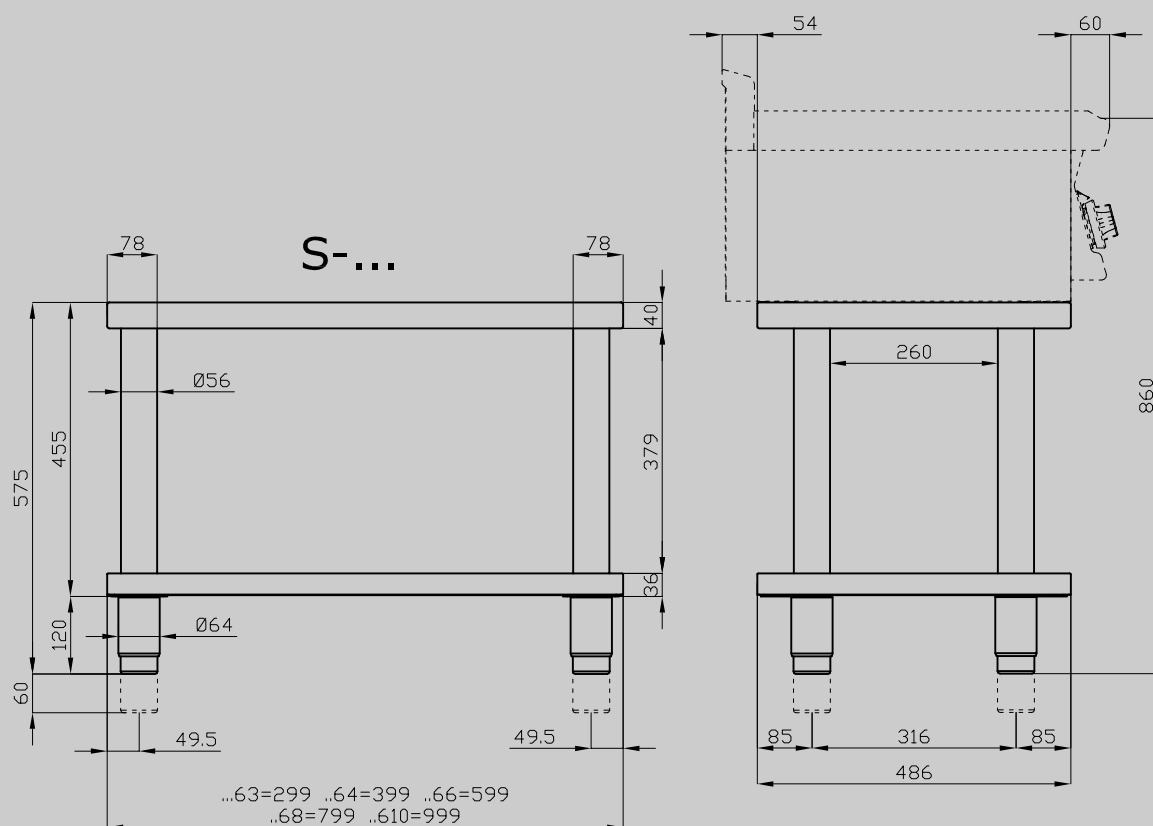

A	Data plate				
---	------------	--	--	--	--

MODEL: S-66  
DIMENSIONS: cm. 60x 48,5x 57h



kg: 23  
m<sup>3</sup>: 0.283  
mm: 630x690x650

BUY LOTUS BUY ITALY

The pictures are purely representative. The manufacturer reserves the right to modify the technical data and models without previous notice.



LOTUS S.P.A. Via Calmaor, 46  
31020 San Vendemiano (TV) - Italy  
Tel. + 39 0438 778020 / 778468  
Fax + 39 0438 778277  
www.lotuscookers.it - lotus@lotuscookers.it