

FTL-1EM

50 SNACK
ELECTRIC GRIDDLE

Electric Fry-top smooth griddle, plate cm.
27x41

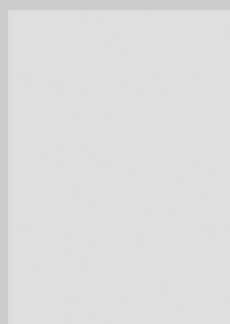

ITALIAN CULINARY ART

The pictures are purely representative. The manufacturer reserves the right to modify the technical data and models without previous notice.

FTL-1EM

50 SNACK
ELECTRIC GRIDDLE

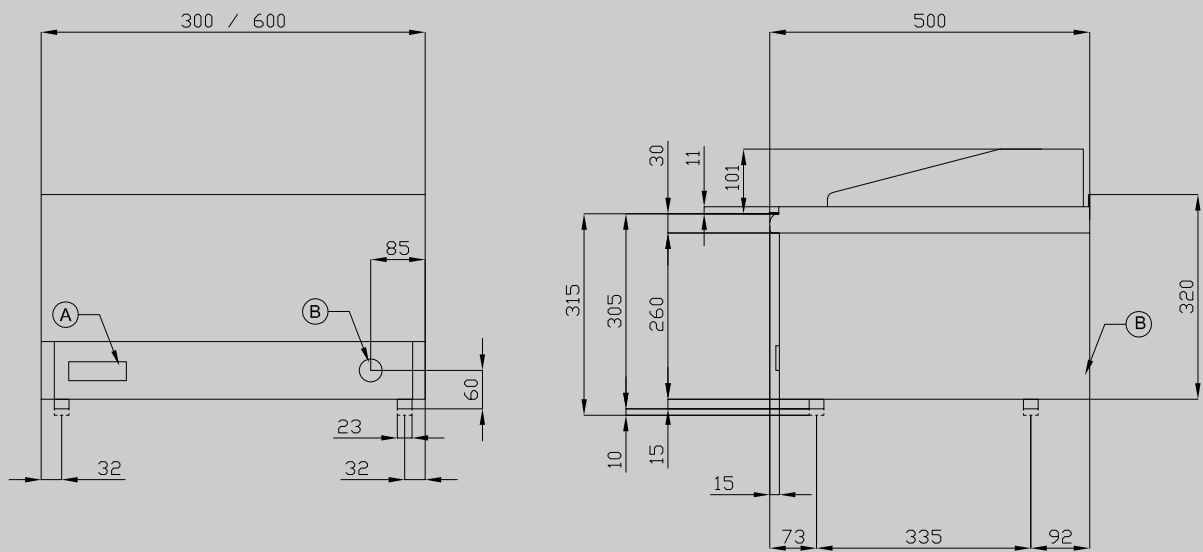

A	Data plate	B	Electrical connection
---	------------	---	-----------------------

MODEL: FTL-1EM
DIMENSIONS: cm. 30x 50x 29h
ELECTRIC POWER: 2,66 kW
VOLTAGE: 230V~
FREQUENCY: 50/60 Hz



kg: 23
m³: 0.148
mm: 330x690x650

BUY LOTUS BUY ITALY

The pictures are purely representative. The manufacturer reserves the right to modify the technical data and models without previous notice.



LOTUS S.P.A. Via Calmaor, 46
31020 San Vendemiano(TV) - Italy
Tel. + 39 0438 778020 / 778468
Fax + 39 0438 778277
www.lotuscookers.it - lotus@lotuscookers.it